

AGILE S4 1800X525

THE INNOVATIVE PALLET TRUCK (1.200 KG)



AGILE

La nueva transpaleta motorizada que combina la función eléctrica y manual y se adapta a cualquier situación.

Compacta, ligera, sencilla y fácil de usar, AGILE es la transpaleta perfecta para reducir el esfuerzo del operador e incrementar su eficacia y seguridad. Ideal para entregas, supermercados y pequeños comercios.



ELECTRIC / MANUAL MODE

The Electric/Manual switch ensures **continuous working** without downtime in case of low battery and makes AGILE as reliable as a standard pallet truck.



LI-ION BATTERY

Easily removable, **lightweight**, high-energy efficiency and totally **maintenance-free**, can be fully or partially recharged, ensuring great productivity.

Two types of charger available (bench and wall mounted) with standard and fast charging time.



- **3H AUTONOMY:** Continuous running with 600 kg average load at full speed.
- **RECHARGE:** Fast and occasional, depending on the combination of battery and charger.
- **CONTINUOUS RUNNING** using spare additional battery.



ADVANCED PERFORMANCES

Powerful and fast, Agile is a smart pallet truck that optimizes your productivity by being more efficient and faster.

- **DOUBLE TRACTION WHEELS WITH NON-MARKING RUBBER:** The first pallet truck with 2 traction wheels in the market, for high stability, better traction and durability.
- **1.2 TONS LOAD CAPACITY:** To cover all logistic needs.
- **AC MOTORS:** Maintenance-free motor grants reduced sound emission (Agile is among the most silent truck in the category), and is specific for intensive working cycles.
- **5.3 KM/H MAX SPEED:** Best in class in light semi-electric category.



EXCEPTIONAL EASE OF USE

The simplicity of Agile and the great maneuverability will immediately help improve your everyday work.

- **COMPACT & LIGHT:** Ideal for use in any application where space and weight is critical.
- **POWERFUL & STABLE:** Ideal for loading/unloading, slopes, uneven floors and everyday last mile deliveries.
- **SIMPLE SWITCH ON/OFF:** Equipped with the practical pocket size key switch, easily removable when the machine is not in use.



USER FRIENDLY FRONT LED INTUITIVE DISPLAY

Equipped with 3 push buttons to make easily settings and read truck activities info. Operator can get information on: Battery status of charge (% of charge); Timers (total and partial trip hour meter in h); Distance traveled (total and partial trip distance in km); Speed adjustment (% of max speed); Diagnostic page; Error page.



MULTI PURPOSES

Agile's drive unit can be combined with forks of any sizes or material like stainless steel, and also with scale system. Whatever model you choose, you will gain all the Agile advantages for the specific needs of your application.

- Special forks size
- Frame for special environments stainless steel or galvanized
- Scale options (GS/P Agile, PX Agile)
- Ultra silent version

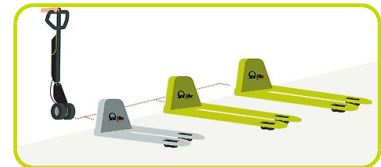

100% SAFETY

Agile is a reputable tool that cares about user safety. No worries anymore, it works hard for you giving superior results in total safety.

- **EASY SPEED ADJUSTMENT:** Safe driving performance according to operator's skill level or to workplace requirements.
- **SAFETY IN NARROW SPACE:** The turtle mode allows for controlled maneuvering in tight spaces.
- **DOUBLE WHEELS SYSTEM:** The large diameter of the wheels allows great stability and smoothness, preventing the pallet truck from overturning.

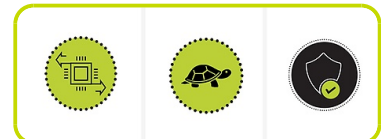

OPTIONS

- **Plus version:** extra power battery 12.8Ah
- Additional **battery** for continuous use
- **Fast** battery charger

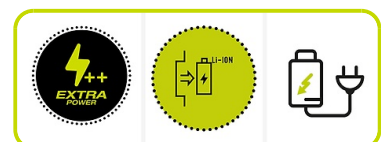

Descripción

1.1 Fabricante			PR INDUSTRIAL
Elevación			Manual
1.3 Grupo tracción			Eléctrico
1.4 Conducción			Acompañante
1.5 Capacidad carga	Q	Kg	1200
1.6 Centro gravedad	c	mm	900
1.8 Distancia de la carga	x	mm	1582
1.9 Distancia entre ejes	y	mm	1842

Pesos

2.1 Peso con batería		Kg	144
2.2 Carga sobre ejes con carga, atras		Kg	810
2.2 Carga sobre ejes con carga, delante		Kg	534
2.3 Carga sobre ejes sin carga, delante		Kg	90
2.3 Carga sobre ejes sin carga, atras		Kg	54

Chasis/Ruedas

3.1 Ruedas delanteras			GOMA
3.1 Ruedas traseras			POLY
3.2 Dimensiones ruedas delanteras - Ancha		mm	40
3.2 Dimensiones ruedas delanteras - Diametro		mm	200
3.3 Dimensiones ruedas traseras - Diametro		mm	82
3.3 Dimensiones ruedas traseras - Ancha		mm	60
3.5 Dimensiones ruedas traseras - Q.ty (X=motriz)		nr	4
3.5 Dimensiones ruedas delanteras - Q.ty (X=motriz)		nr	2x
3.6 Vía delantera	b10	mm	162
3.7 Vía trasera	b11	mm	375

Dimensiones

4.4 Elevación	h3	mm	115
4.9 Altura del timón max	h14	mm	1185
4.9 Altura del timón min	h14	mm	710
4.15 Altura horquillas bajadas	h13	mm	85
4.19 Longitud total	l1	mm	2250
4.20 Longitud de timón a horquillas	l2	mm	450
4.21 Ancho total	b1	mm	525
4.22 Dimensiones horquillas	s	mm	55
4.22 Dimensiones horquillas	e	mm	150
4.22 Dimensiones horquillas	l	mm	1800
4.25 Ancho horquillas	b5	mm	525
4.32 Altura libre inferior, con carga, al centro entre ejes	m2	mm	30
4.34 Pasillo de trabajo para palet 800x1200 longit.	Ast	mm	2688
4.35 Radio de giro	Wa	mm	2032

Prestaciones

5.1 Velocidad de tracción con carga	Km/h	4.2
5.1 Velocidad de tracción sin carga	Km/h	5.3
5.2 Velocidad de elevación con carga	bombeos	12
5.2 Velocidad de elevación sin carga	bombeos	12
5.3 Velocidad de descenso con carga	m/s	0.1
5.3 Lowering speed unladen	m/s	0.02
5.8 Máx. pendiente con carga	%	5
5.8 Máx. pendiente sin carga	%	10
5.10 Freno De Servicio		Eléctrico

Motores eléctricos

6.1 Potencia del motor de tracción	kW	2x0.25
Tipo de batería	Type	Li-ion
6.4 Voltaje batería	V	36
6.4 Capacidad de la Batería	Ah	10.4
6.5 Peso de la batería	kg	3
8.4 Nivel sonoro al oído del conductor	dB(A)	60

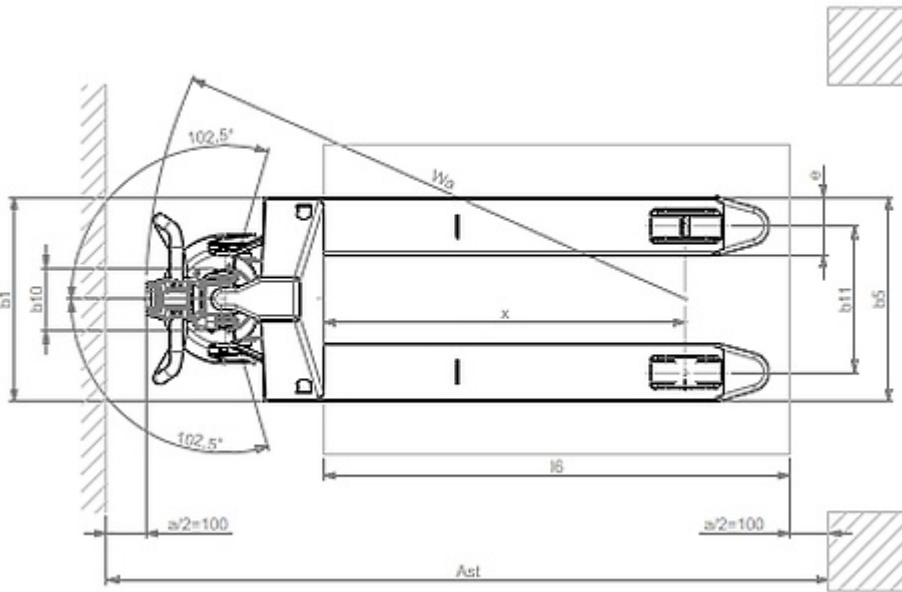
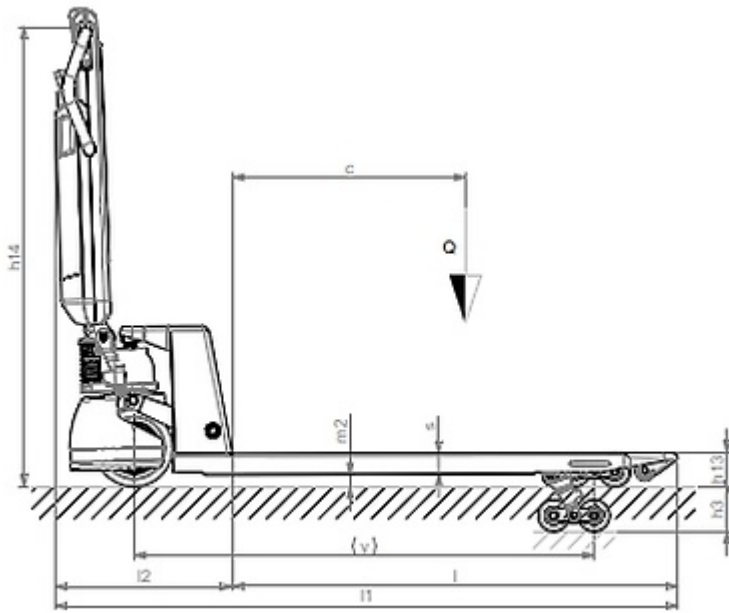

The information is aligned with the Data file at the time of download. Printed on 16/06/2022 (ID 17503)

©2022 | PR INDUSTRIAL s.r.l. | All rights reserved | Image shown may not reflect actual package. Specifications subject to change without notice